

VIEW "A"
(SCALE : 2/1)

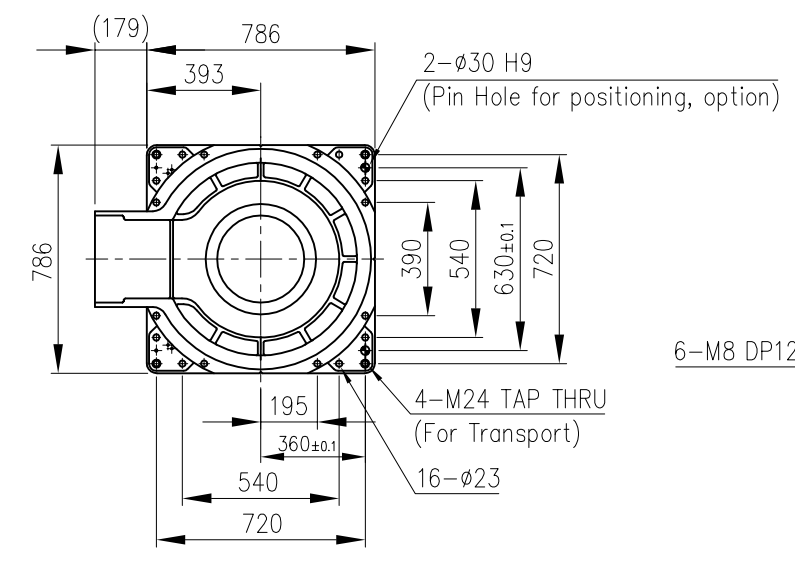

VIEW "B"

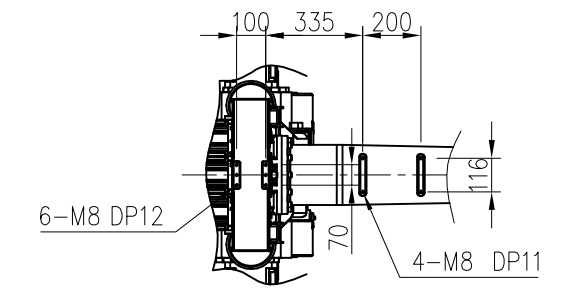

VIEW "E"

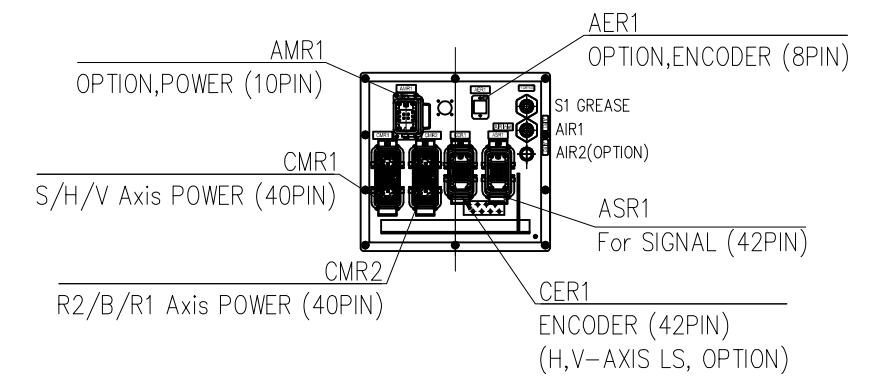
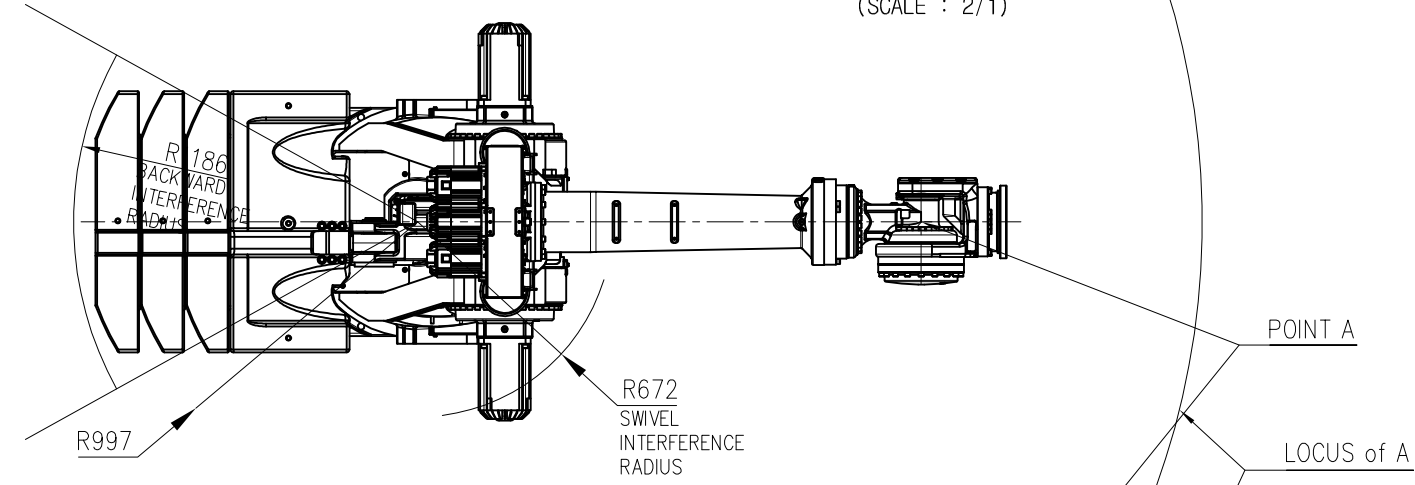

VIEW "C" <For Hi5a Controller>
(SCALE : 2/1)

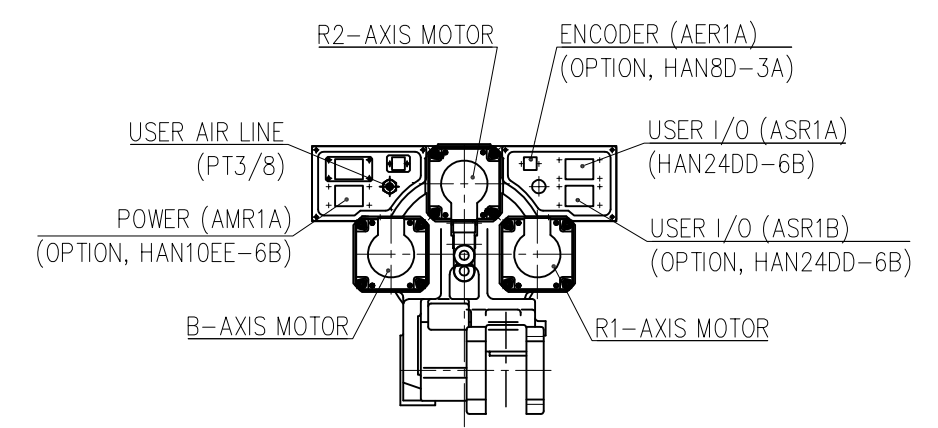
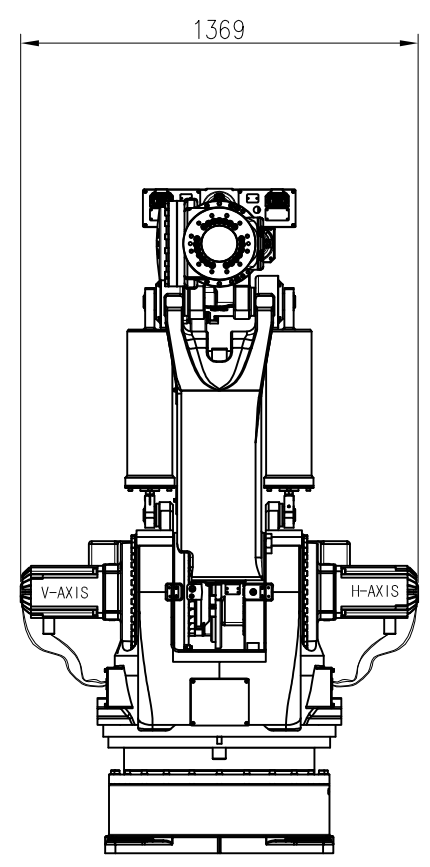
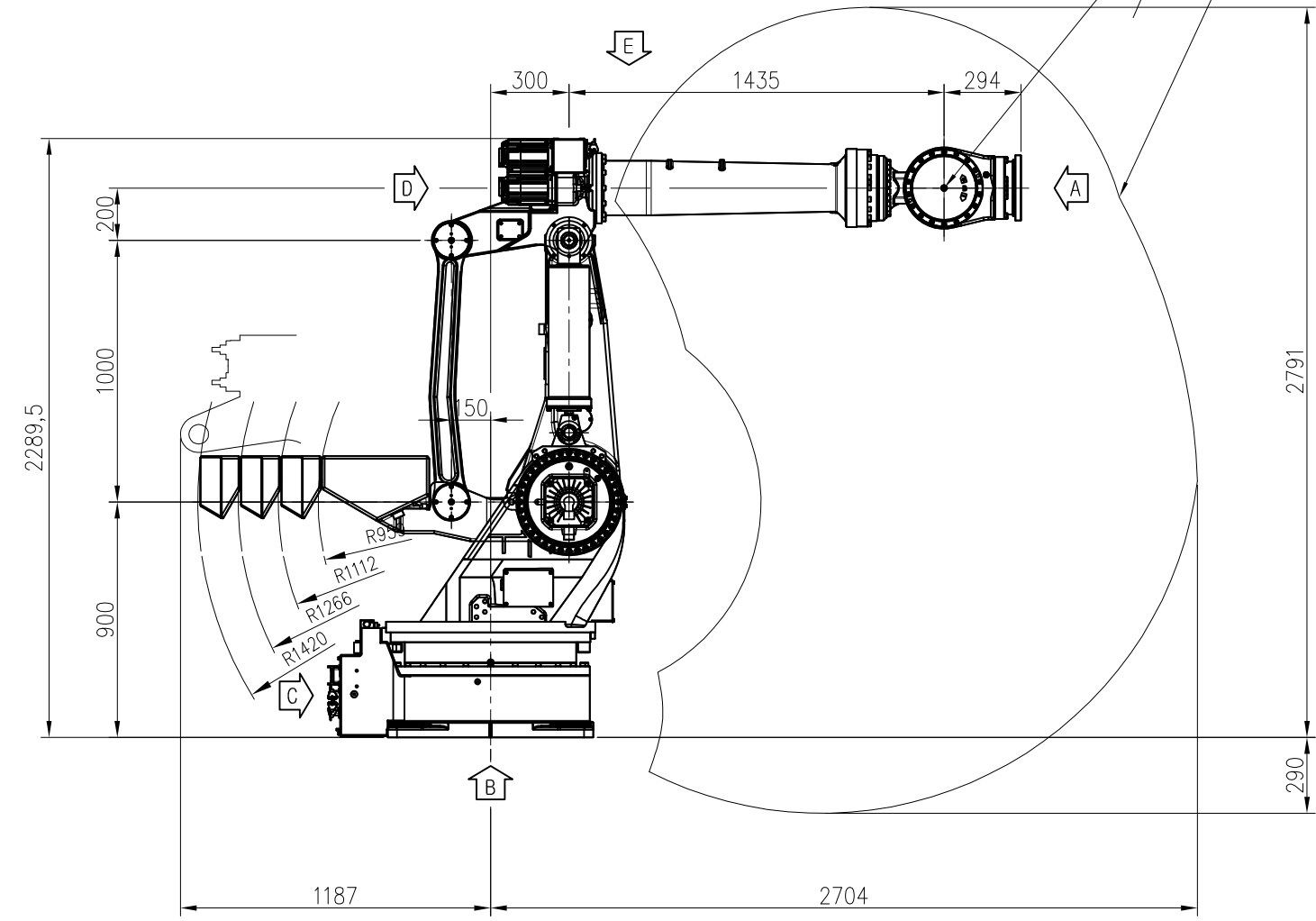

VIEW "D"
(SCALE : 2/1)

MODEL	HX600	issue.0
DATE	2018.10.04	

TECHNICAL SPECIFICATION SUBJECT TO CHANGE WITHOUT NOTICE

